

IGBT with on-chip Gate-Emitter and Gate-Collector clamps

Features

- Most Rugged in Industry
- Logic-Level Gate Drive
- > 6KV ESD Gate Protection
- Low Saturation Voltage
- High Self-clamped Inductive Switching Energy

Description

The advanced IGBT process family includes a MOS gated, N-channel logic level device which is intended for coil-on-plug automotive ignition applications and small-engine ignition circuits. Unique features include on-chip active voltage clamps between the Gate-Emitter and Gate-Collector which provide over voltage protection capability in ignition circuits.

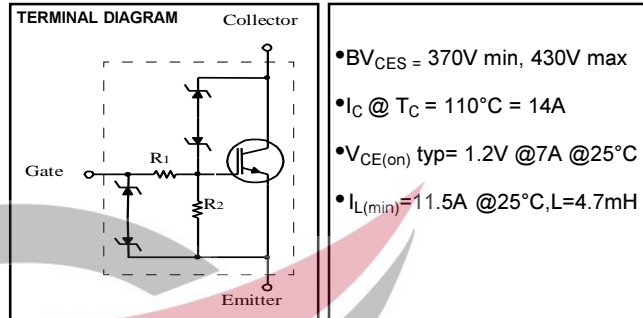

- $BV_{CES} = 370V$ min, $430V$ max
- $I_C @ T_C = 110^\circ C = 14A$
- $V_{CE(on)}$ typ= $1.2V @ 7A @ 25^\circ C$
- $I_{L(min)} = 11.5A @ 25^\circ C, L = 4.7mH$



NOTE: IRGS14C40L is available in tape and reel. Add a suffix of TRR or TRL to the part number to determine the orientation of the device in the pocket, i.e, IRGS14C40LTRR or IRGS14C40LTRL.

Absolute Maximum Ratings

	Parameter	Max	Unit	Condition
V_{CES}	Collector-to-Emitter Voltage	Clamped	V	$R_G = 1K$ ohm
$I_C @ T_C = 25^\circ C$	Continuous Collector Current	20	A	$V_{GE} = 5V$
$I_C @ T_C = 110^\circ C$	Continuous Collector Current	14	A	$V_{GE} = 5V$
I_G	Continuous Gate Current	1	mA	
I_{Gp}	Peak Gate Current	10	mA	$t_{PK} = 1ms, f = 100Hz$
V_{GE}	Gate-to-Emitter Voltage	Clamped	V	
$P_D @ T_C = 25^\circ C$	Maximum Power Dissipation	125	W	
$P_D @ T = 110^\circ C$	Maximum Power Dissipation	54	W	
T_J	Operating Junction and	- 40 to 175	$^\circ C$	
T_{STG}	Storage Temperature Range	- 40 to 175	$^\circ C$	
V_{ESD}	Electrostatic Voltage	6	KV	$C = 100pF, R = 1.5K$ ohm
I_L	Self-clamped Inductive Switching Current	11.5	A	$L = 4.7mH, T = 25^\circ C$

Thermal Resistance

	Parameter	Min	Typ	Max	Unit
$R_{\theta JC}$	Thermal Resistance, Junction-to-Case			1.2	$^\circ C/W$
$R_{\theta JA}$	Thermal Resistance, Junction-to-Ambient			40	
	(PCB Mounted, Steady State)				
$Z_{\theta JC}$	Transient Thermal Impedance, Junction-to-Case (Fig.11)				

Off-State Electrical Characteristics @ $T_J = 25^\circ\text{C}$ (unless otherwise specified)

	Parameter	Min	Typ	Max	Unit	Conditions	Fig
BV_{CES}	Collector-to-Emitter Breakdown Voltage	370	400	430	V	$R_G = 1\text{K ohm}, I_C = 7\text{A}, V_{GE} = 0\text{V}$	
BV_{GES}	Gate-to-Emitter Breakdown Voltage	10	12		V	$I_G = 2\text{m A}$	
I_{CES}	Collector-to-Emitter Leakage Current			15	μA	$R_G = 1\text{K ohm}, V_{CE} = 250\text{V}$	
				100	μA	$R_G = 1\text{K ohm}, V_{CE} = 250\text{V}, T_J = 150^\circ\text{C}$	
BV_{CER}	Emitter-to-Collector Breakdown Voltage	24	28		V	$I_C = -10\text{m A}$	
R_1	Gate Series Resistance		75		ohm		
R_2	Gate-to-Emitter Resistance	10	20	30	K ohm		

On-State Electrical Characteristics @ $T_J = 25^\circ\text{C}$ (unless otherwise specified)

	Parameter	Min	Typ	Max	Unit	Conditions	Fig
$V_{CE(on)}$	Collector-to-Emitter Saturation Voltage		1.2	1.40	V	$I_C = 7\text{A}, V_{GE} = 4.5\text{V}$	1
			1.35	1.55		$I_C = 10\text{A}, V_{GE} = 4.5\text{V}$	
			1.35	1.55	V	$I_C = 10\text{A}, V_{GE} = 4.5\text{V}, T_C = -40^\circ\text{C}$	4
			1.5	1.7		$I_C = 14\text{A}, V_{GE} = 5.0\text{V}, T_C = -40^\circ\text{C}$	
			1.55	1.75		$I_C = 14\text{A}, V_{GE} = 5.0\text{V}$	
	1.6	1.8	$I_C = 14\text{A}, V_{GE} = 5.0\text{V}, T_C = 150^\circ\text{C}$				
$V_{GE(th)}$	Gate Threshold Voltage	1.3	1.8	2.2	V	$V_{CE} = V_{GE}, I_C = 1\text{ m A}, T_C = 25^\circ\text{C}$	3, 5
		0.75		1.8		$V_{CE} = V_{GE}, I_C = 1\text{ m A}, T_C = 150^\circ\text{C}$	8
g_{fs}	Transconductance	10	15	19	S	$V_{CE} = 25\text{V}, I_C = 10\text{A}, T_C = 25^\circ\text{C}$	
I_C	Collector Current	20			A	$V_{CE} = 10\text{V}, V_{GE} = 4.5\text{V}$	

Switching Characteristics @ $T_J = 25^\circ\text{C}$ (unless otherwise specified)

	Parameter	Min	Typ	Max	Unit	Conditions	Fig
Q_g	Total Gate charge		27		nC	$I_C = 10\text{A}, V_{CE} = 12\text{V}, V_{GE} = 5\text{V}$	7
Q_{ge}	Gate - Emitter Charge		2.5			$I_C = 10\text{A}, V_{CE} = 12\text{V}, V_{GE} = 5\text{V}$	15
Q_{gc}	Gate - Collector Charge		10			$I_C = 10\text{A}, V_{CE} = 12\text{V}, V_{GE} = 5\text{V}$	
$t_{d(on)}$	Turn - on delay time	0.6	0.9	1.35	μs	$V_{GE} = 5\text{V}, R_G = 1\text{K ohm}, L = 1\text{mH}, V_{CE} = 14\text{V}$	12
t_r	Rise time	1.6	2.8	4		$V_{GE} = 5\text{V}, R_G = 1\text{K ohm}, L = 1\text{mH}, V_{CE} = 14\text{V}$	14
$t_{d(off)}$	Turn - off delay time	3.7	6	8.3		$V_{GE} = 5\text{V}, R_G = 1\text{K ohm}, L = 1\text{mH}, V_{CE} = 300\text{V}$	
C_{ies}	Input Capacitance		550	825	pF	$V_{GE} = 0\text{V}, V_{CE} = 25\text{V}, f = 1\text{M H z}$	6
C_{oes}	Output Capacitance		100	150		$V_{GE} = 0\text{V}, V_{CE} = 25\text{V}, f = 1\text{M H z}$	
C_{res}	Reverse Transfer Capacitance		12	18		$V_{GE} = 0\text{V}, V_{CE} = 25\text{V}, f = 1\text{M H z}$	
I_L	Self-Clamped Inductive Switching Current	25			A	$L = 0.7\text{m H}, T_C = 25^\circ\text{C}$	9
		15.5				$L = 2.2\text{m H}, T_C = 25^\circ\text{C}$	
		11.5				$L = 4.7\text{m H}, T_C = 25^\circ\text{C}$	10
		16.5				$L = 1.5\text{m H}, T_C = 150^\circ\text{C}$	13
		7.5				$L = 4.7\text{m H}, T_C = 150^\circ\text{C}$	14
		6			$L = 8.7\text{m H}, T_C = 150^\circ\text{C}$		
t_{sc}	Short Circuit Withstand Time	120			μs	$T_J = 150^\circ\text{C},$ $V_{CC} = 16\text{V}, L = 10\mu\text{H}$ $R_G = 1\text{K ohm}, V_{GE} = 5\text{V}$	14

Fig.1 - Typ. Output Characteristics
 $T_J=25^\circ\text{C}$

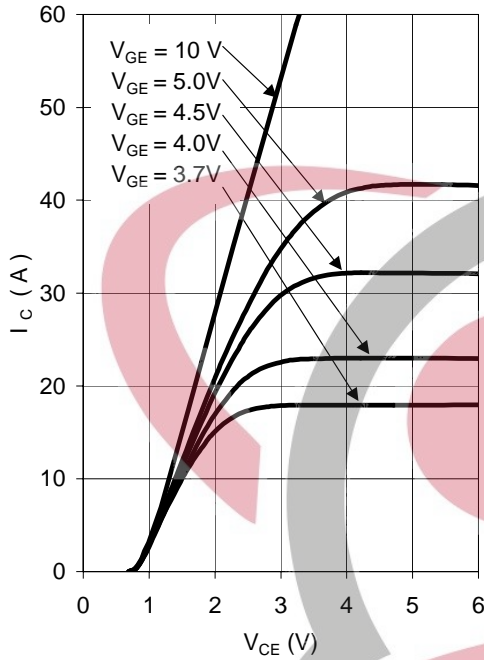

Fig.2 - Typ. Output Characteristics
 $T_J=125^\circ\text{C}$

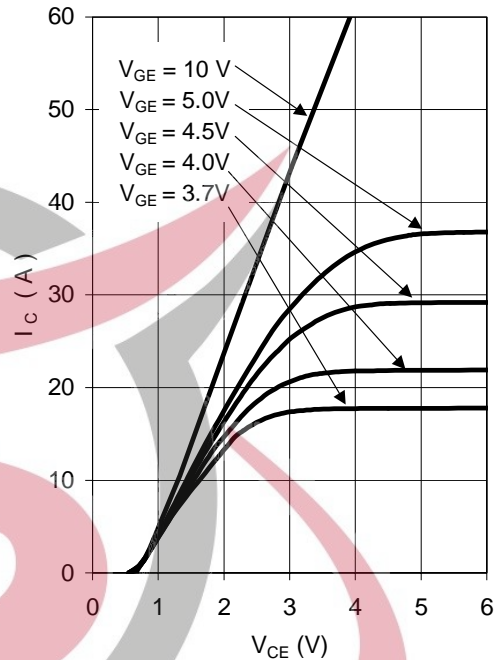

Fig.3 - Transfer Characteristics
 $V_{CE}=20\text{V}; t_p=20\mu\text{s}$

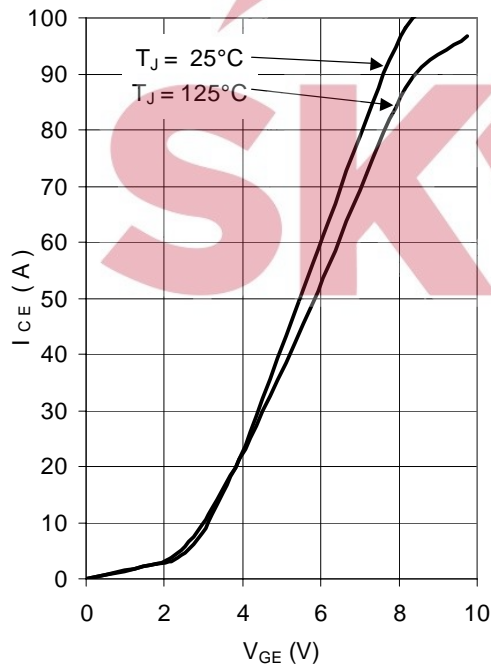
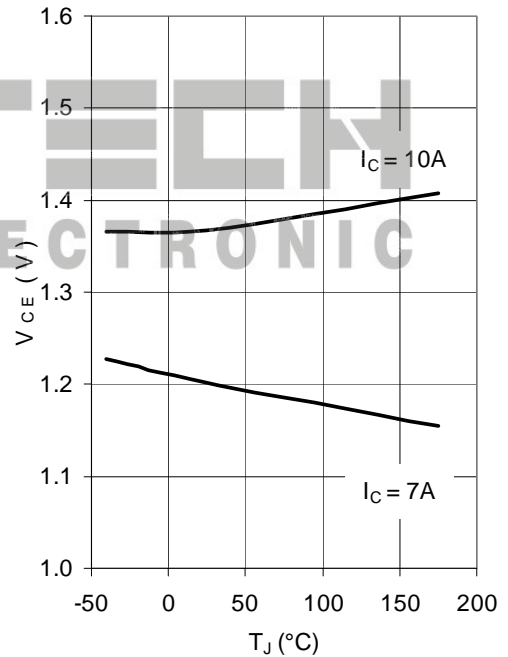

Fig.4 - Typical V_{CE} vs T_J
 $V_{GE}=4.5\text{V}$



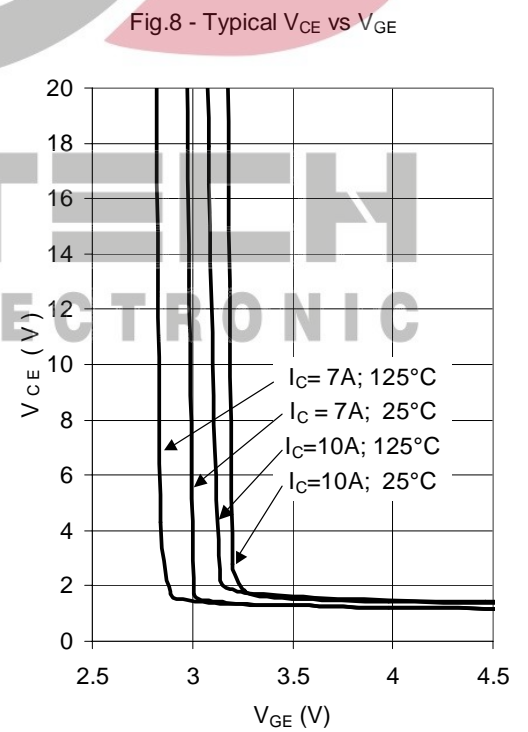
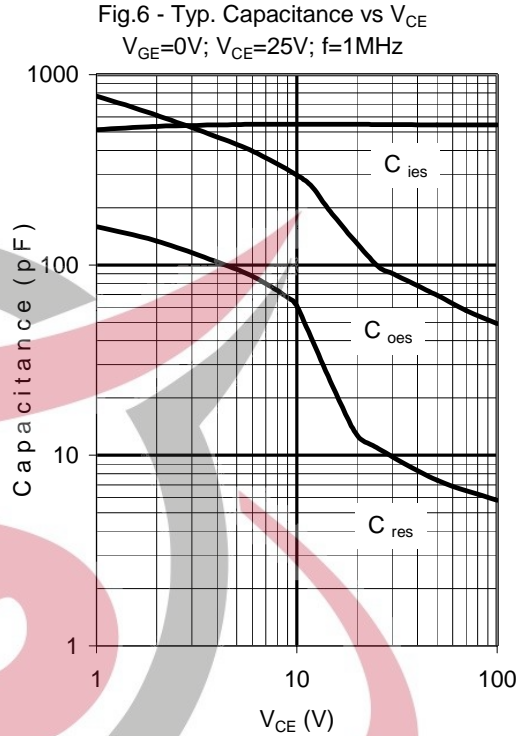
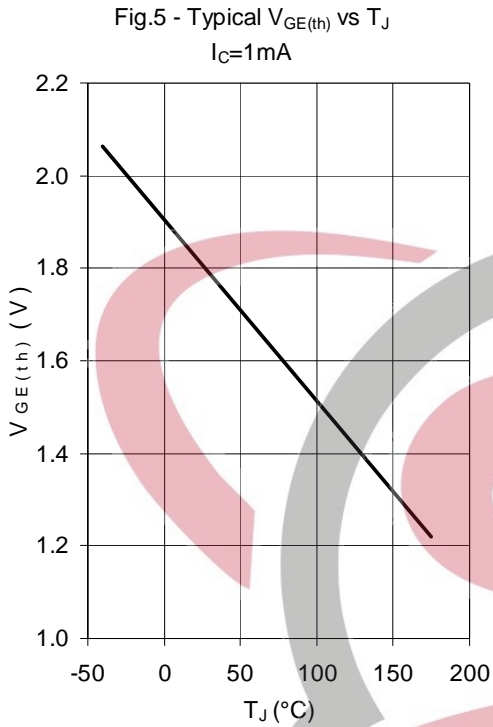

Fig.9 - Self-clamp Avalanche Current vs Inductance @ 25°C

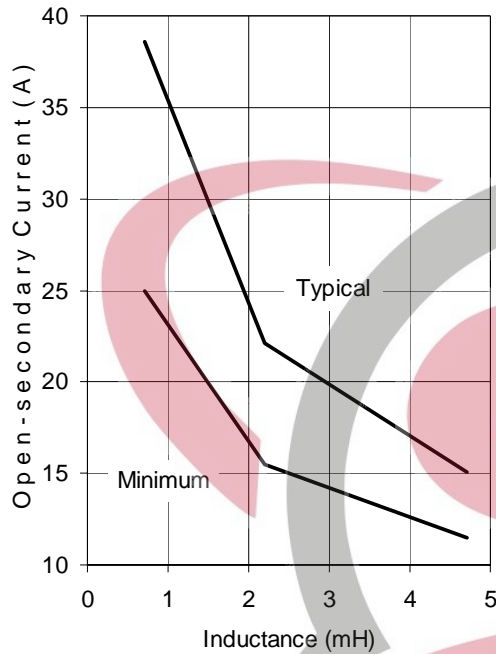

Fig.10 - Self-clamp Avalanche Current vs Inductance @ 150°C

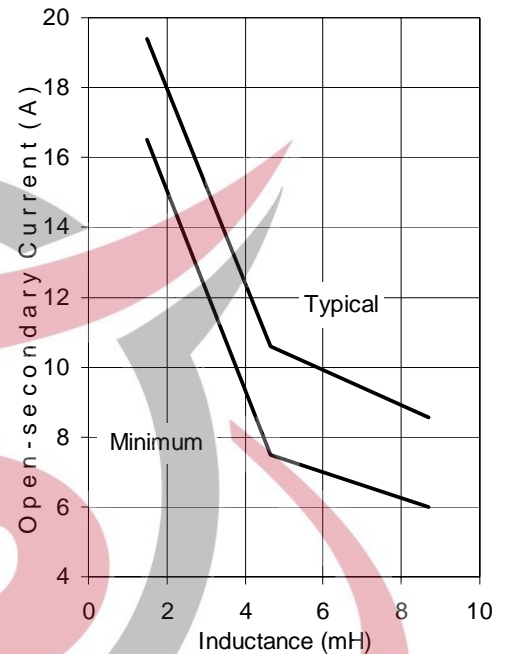

Fig.11 - Transient Thermal Impedance, Junction-to-Case

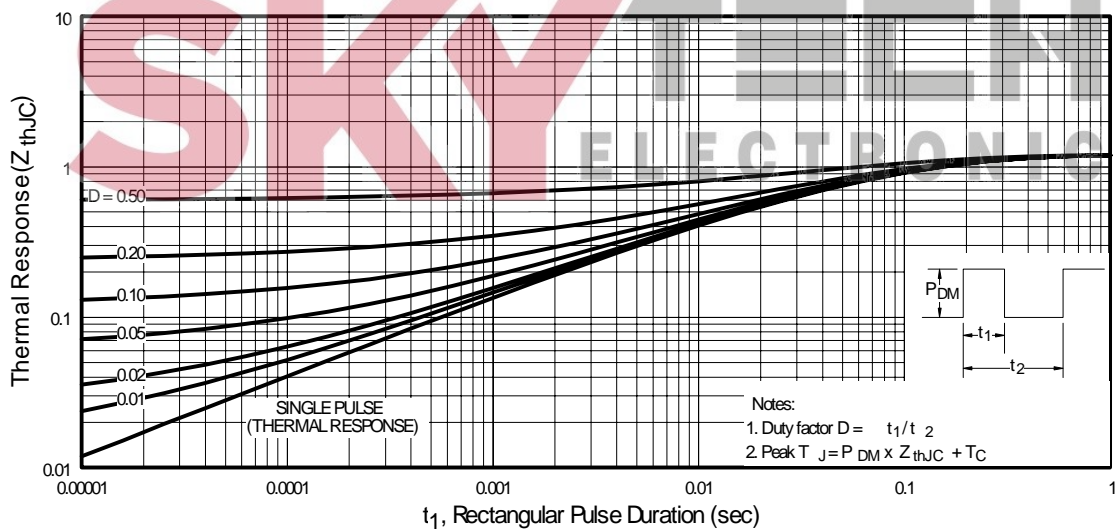

Fig.12 - Switching Waveform for Time Measurement

$V_{GE}= 5V$; $R_G= 1K\Omega$; $L= 1mH$; $V_{CE}= 14V$; used circuit in Fig.14

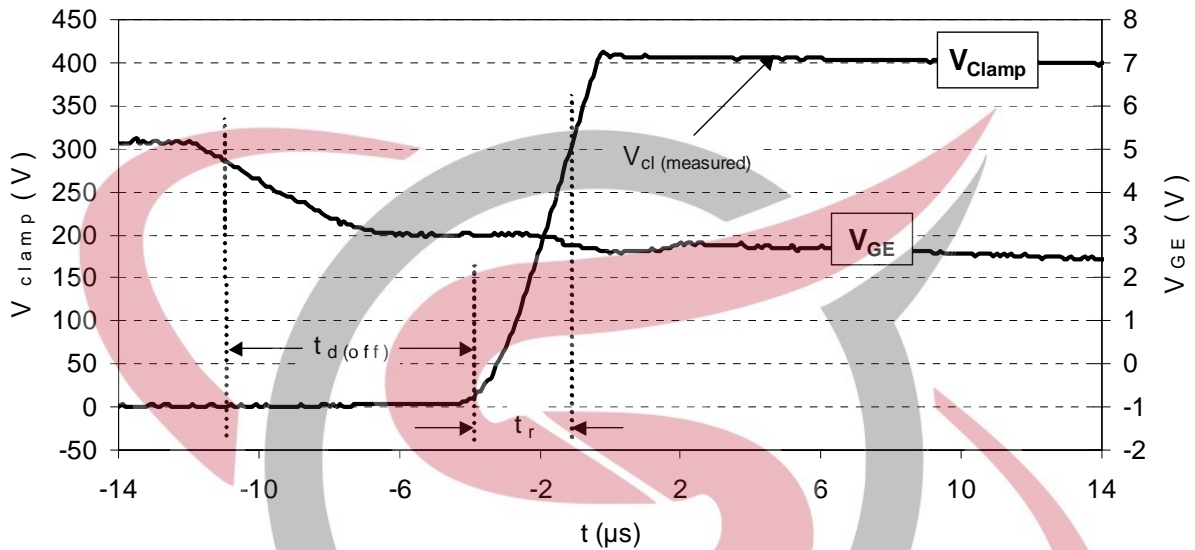

Fig.13 - Self-clamped Inductive Switching Waveform

$L=4.7mH$; $T_C=25^\circ C$; used circuit in Fig.14

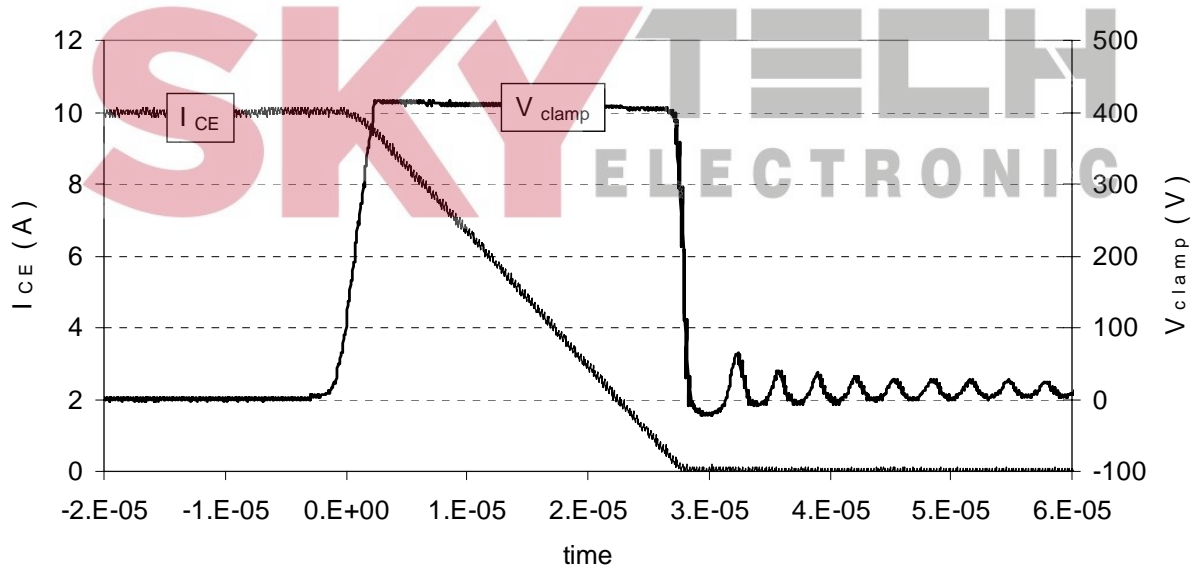

Fig.14 - Test Circuit

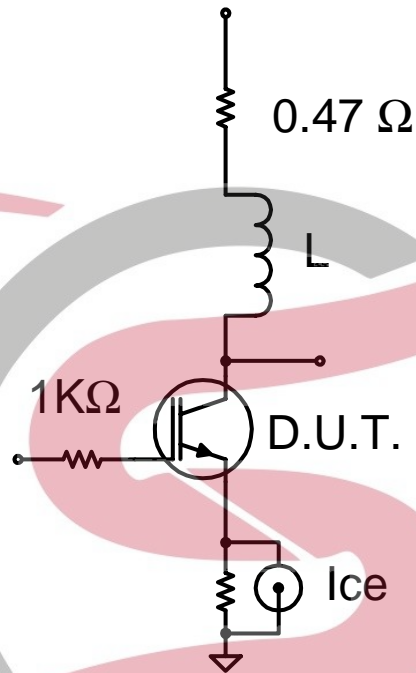
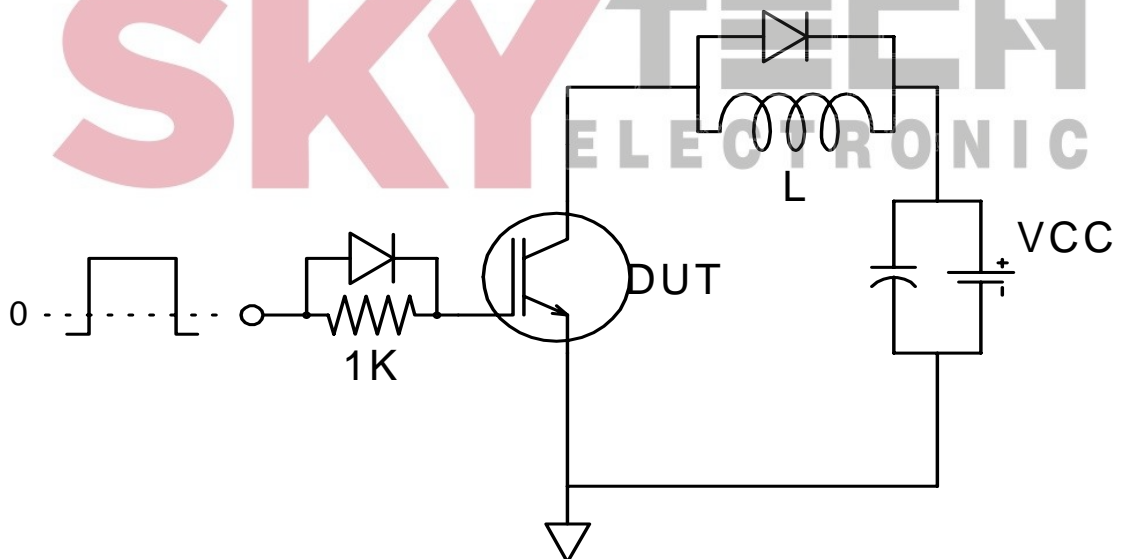
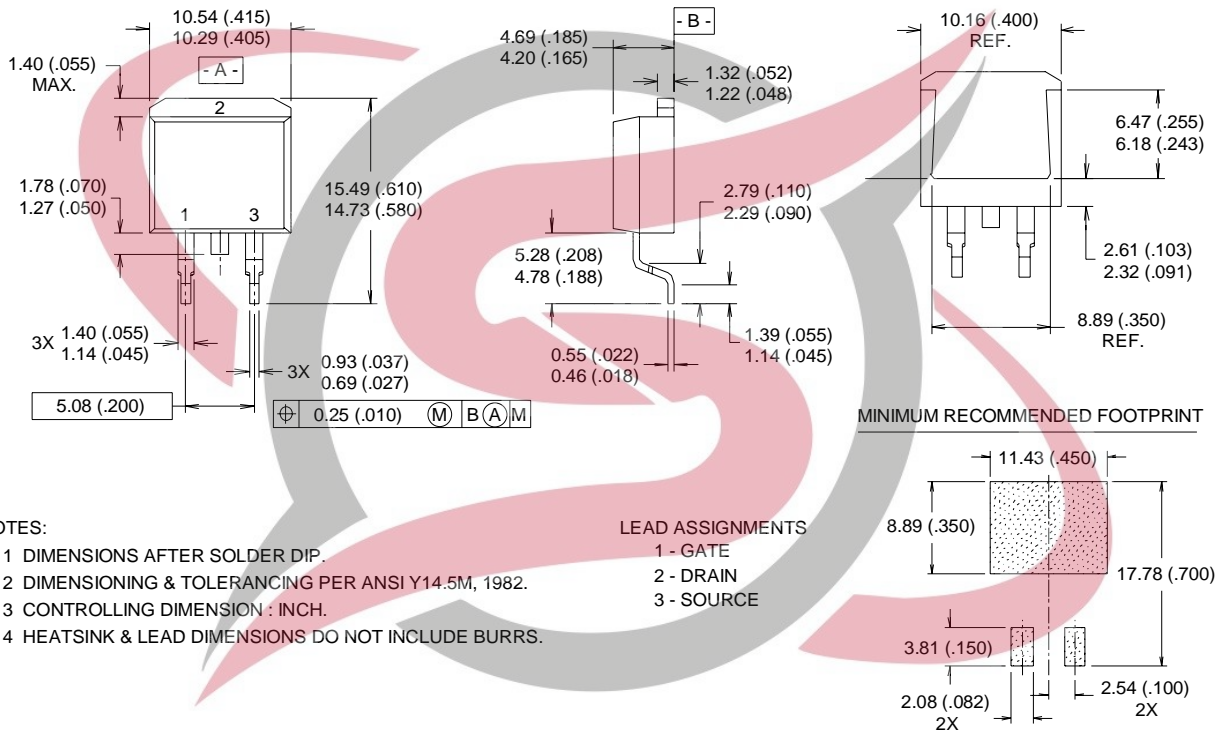

Fig.15 - Gate Charge Circuit



TO-263AB Package Outline
 Dimensions are shown in millimeters (inches)



NOTES:

- 1 DIMENSIONS AFTER SOLDER DIP.
- 2 DIMENSIONING & TOLERANCING PER ANSI Y14.5M, 1982.
- 3 CONTROLLING DIMENSION : INCH.
- 4 HEATSINK & LEAD DIMENSIONS DO NOT INCLUDE BURRS.

LEAD ASSIGNMENTS

- 1 - GATE
- 2 - DRAIN
- 3 - SOURCE



TO-263AB Package Outline in Tape and Reel

Dimensions are shown in millimeters (inches)

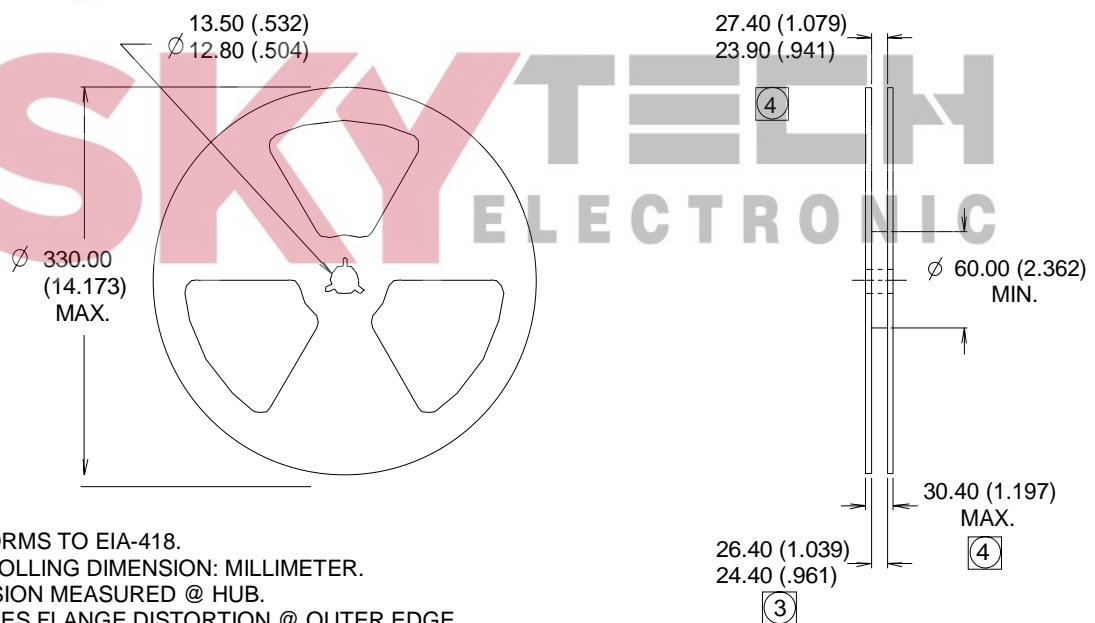
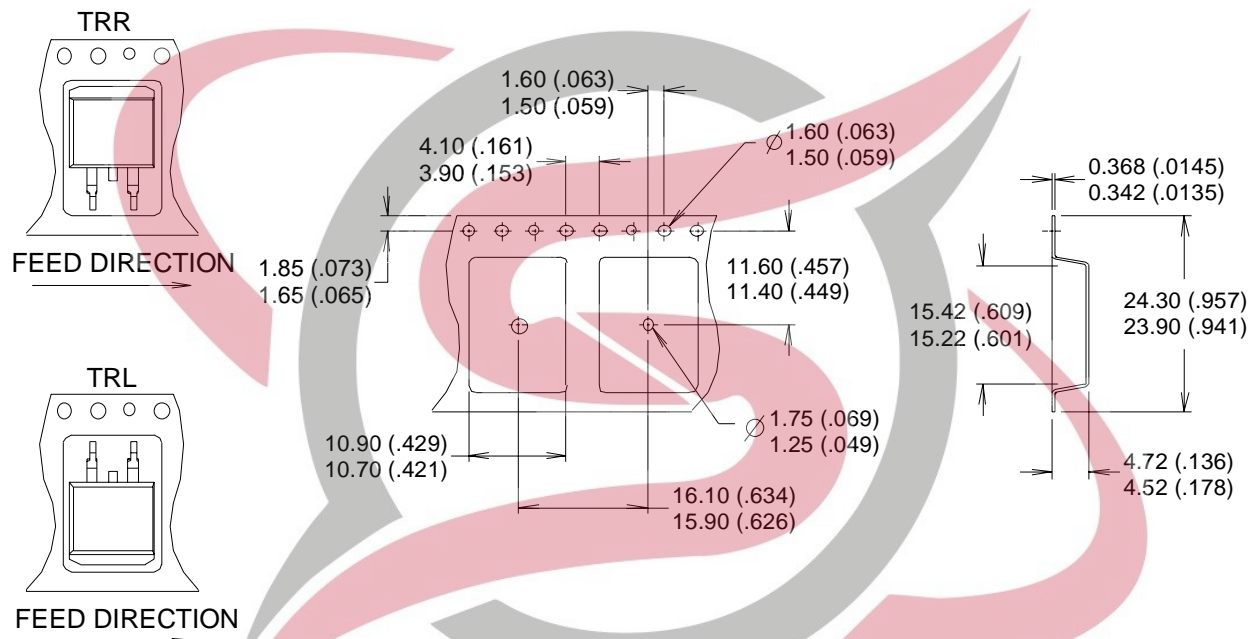

NOTES :

1. CONFORMS TO EIA-418.
2. CONTROLLING DIMENSION: MILLIMETER.
- ③ DIMENSION MEASURED @ HUB.
- ④ INCLUDES FLANGE DISTORTION @ OUTER EDGE.

TO-262AA Package Outline

Dimensions are shown in millimeters (inches)

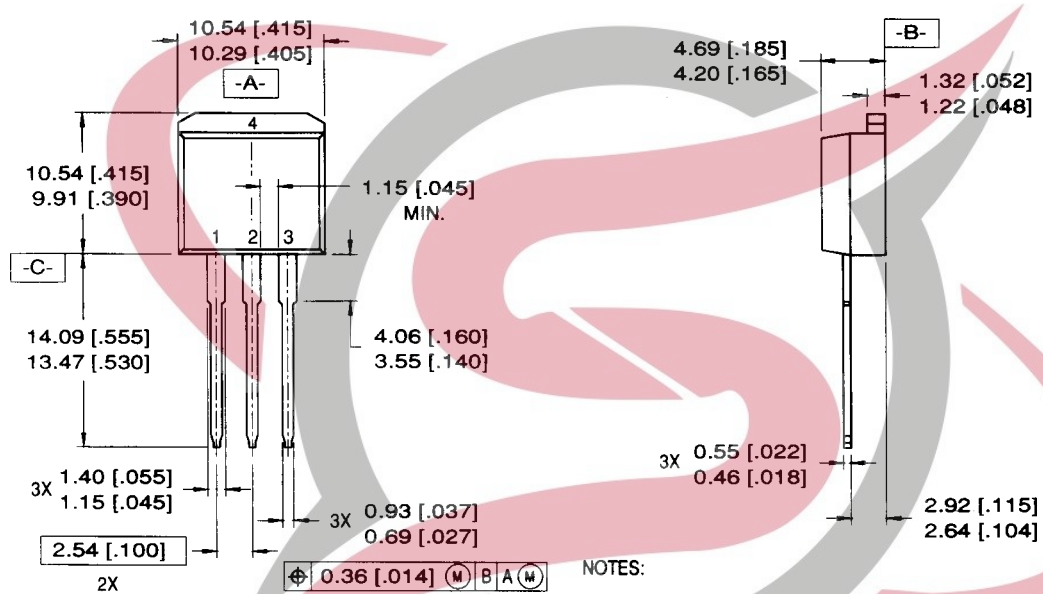

LEAD ASSIGNMENTS

- 1 = GATE 3 = SOURCE
 2 = DRAIN 4 = DRAIN

NOTES:

1. DIMENSIONING & TOLERANCING PER ANSI Y14.5M-1982
2. CONTROLLING DIMENSION: INCH.
3. DIMENSIONS ARE SHOWN IN MILLIMETERS [INCHES].
4. HEATSINK & LEAD DIMENSIONS DO NOT INCLUDE BURRS.



TO-220AB Package Outline

Dimensions are shown in millimeters (inches)

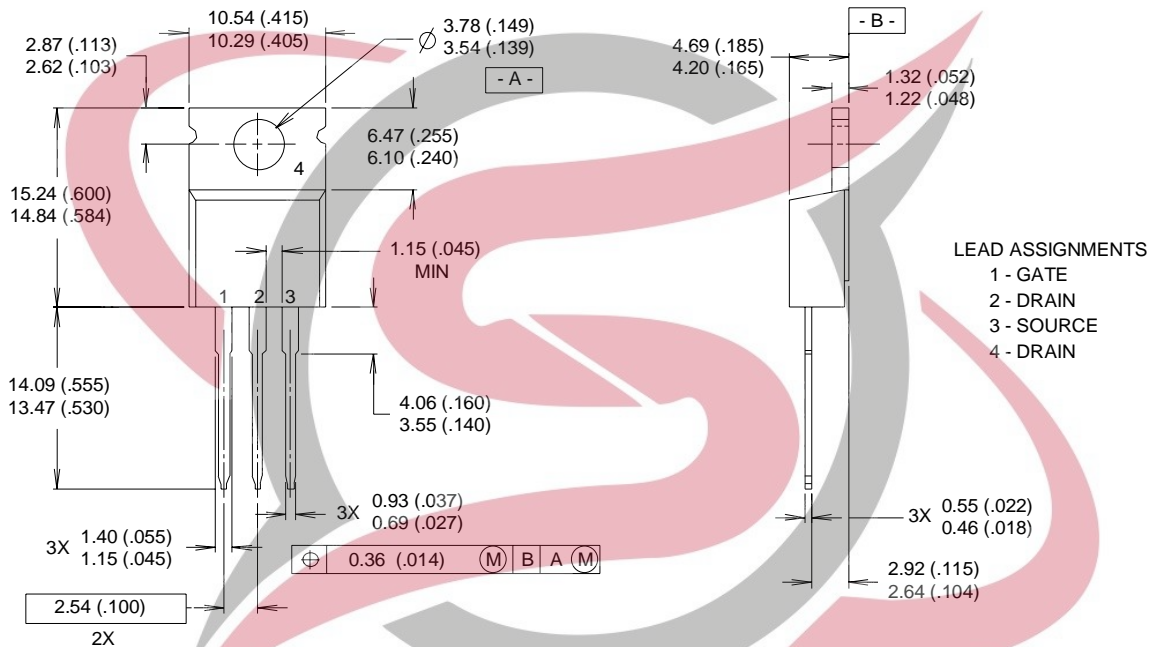

NOTES:

- 1 DIMENSIONING & TOLERANCING PER ANSI Y14.5M, 1982.
- 2 CONTROLLING DIMENSION : INCH
- 3 OUTLINE CONFORMS TO JEDEC OUTLINE TO-220AB.
- 4 HEATSINK & LEAD MEASUREMENTS DO NOT INCLUDE BURRS.



Note: For the most current drawings please refer to the IR website at:
<http://www.irf.com/package/>

